

VALID FROM 09/06/2016

Inground option

WARNING:

It's essential to keep a minimum clearance access of **700mm** all around.

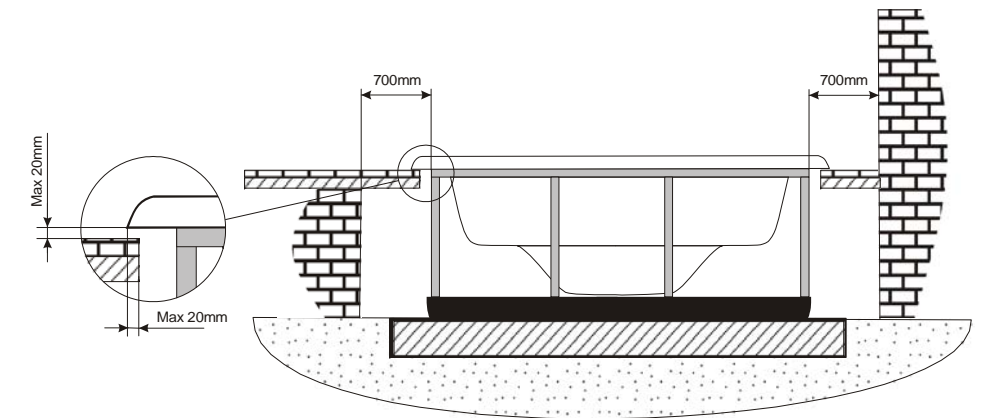

ELECTRICAL BOARD CONNECTIONS ACCESS

According to our policy of continuous improvement, dimensions, features or components of this product can be partially or completely changed without prior notice. It's Customer responsibility to verify that this is the last version of the drawing

Change No.	Date	Name	Modification
02	09/06/2016	I.Pozo	Change blower pump and add audio
01	17/03/2016	I.Pozo	New spare template
00	13/01/2016	I.Pozo	Creation

Remarks Dimensions in mm. General Tolerances +/- 10mm			COMMERCIAL		
Drawn	13/01/2016	I.Pozo		Part Number 66031	Rev. 02
Checked		V.Saiz			
Scale	1:15	General Tolerance DIN 7168 ISO 2768g			
Sheet	1/3				

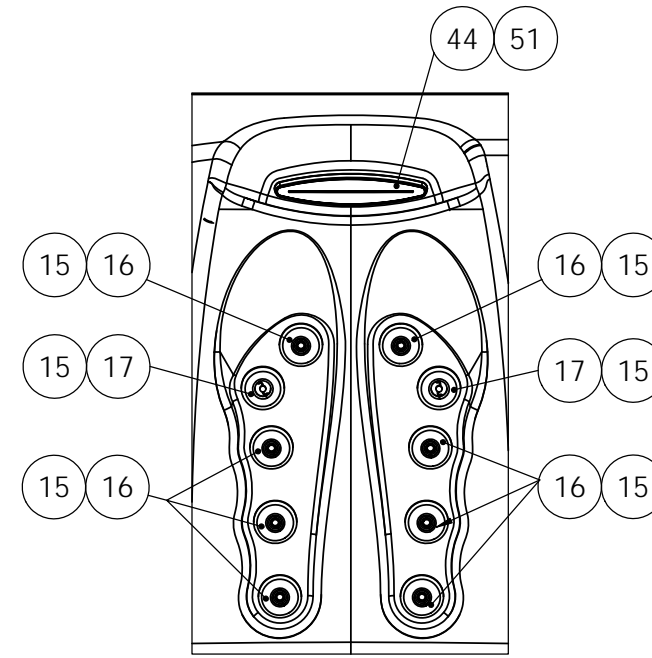
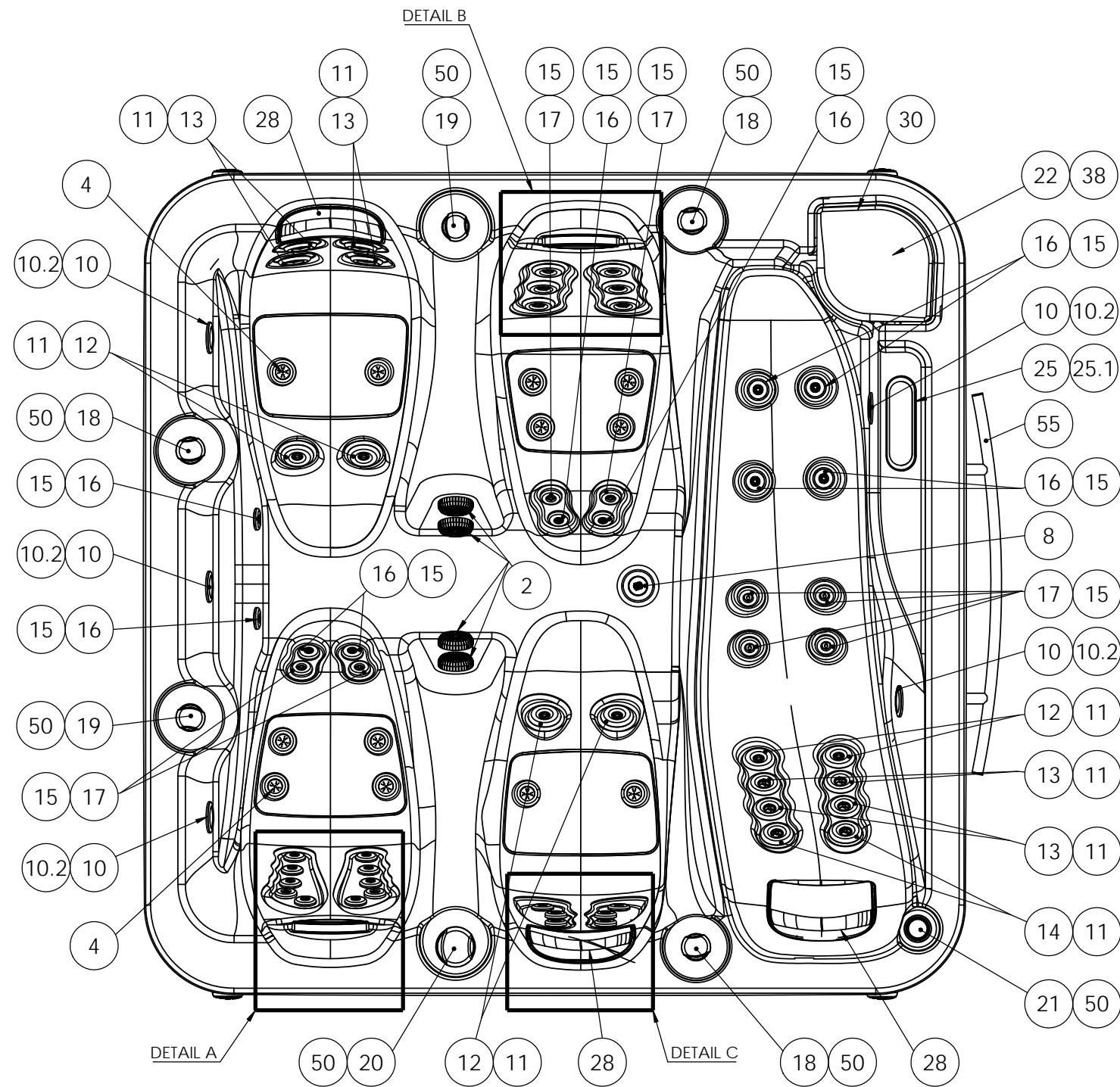

A (1 : 10)

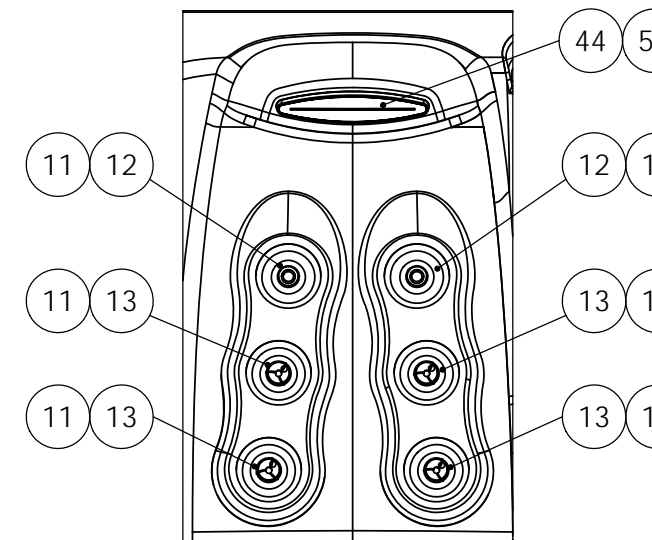

B (1 : 10)

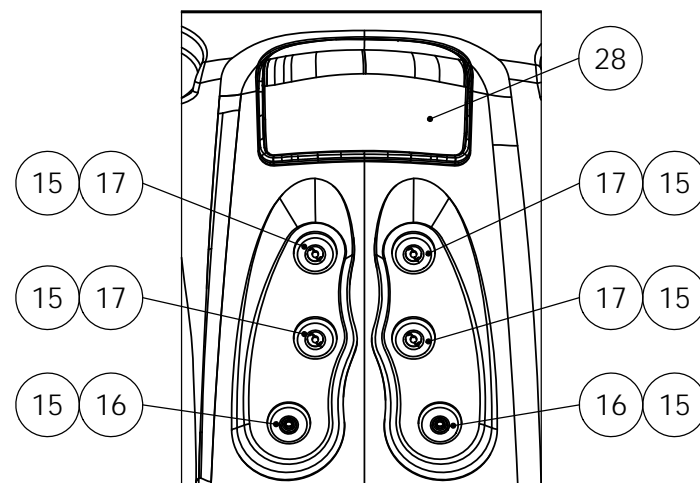



C (1 : 10)

ACCESSORIES			
Position Num.	Part Nº SPARE	Description SPARE	Quant.
2	RPOR0275	SS SPA DRAIN 2" ADAPTOR SOCKET D.50	4
4	REMP0046	WHITE-STAINLESS STEEL AIR NOZZLE	12
8	RPOR0003	GREY DRAIN SET - BODY+COVER+ASSEMBLY	1
10	RPOR0239	SPOTLIGHT LED SET RD	5
10.2	RPOR0252	LED SLAVE LIGHT	5
11	RPOR0236	JET BODY SET RD 3"	22
12	RPOR0231	FRONTAL JET 3" STAINLESS STEEL DIRECTIONAL	8
13	RPOR0232	FRONTAL JET 3" STAINLESS STEEL 1 JET ROTO	12
14	RPOR0233	FRONTAL JET 3" STAINLESS STEEL TWIN ROTO	2
15	RPOR0235	JET BODY SET RD 2"	34
16	RPOR0230	FRONTAL JET 2" STAINLESS STEEL DIRECTIONAL	20
17	RPOR0260	JET TWIN ROTO 2" INOX	14
18	RPOR0261	VENTURY CONTROLLER SS	3
19	RPOR0263	VALVE ON-OFF 1" SS	2
20	RPOR0262	3 WAYS SS VALVE 2"	1
21	RPOR0264	AROMA DISPENSER ASM LIT	1
22	RPOR0238	SKIMERFILTER RD LOW PROFILE	1
25	RPOR0196	DIGITAL PANEL VL700+COVER 2 PUMP + BLOWER	1
25.1	RPOR0202	COVER DIGITAL PANEL VL700 2 PUMP + BLOWER	1
28	RPOR0032	SMALL HEADREST GREY	3
30	RPOR0156	SKIMFILTER COVER	1
38	RPOR0247	FILTER CARTRIDGE SKIMFILTER RD	1
44	RPOR0278	SS 7" WATERFALL	2
49	RPOR0136	DRAIN FILL VALVE (BLACK)	1
50	RPOR0267	4 LEDS LIGHTS POINTS	7
51	RPOR0268	1 LED LIGHT POINT	4
55	RPOR0198	SPECIAL HANDGRIP SPA 1000	1
70	RPOR0280	LEDS TRANSFORMER 5V DC	1
71	RPOR0281	LEDS CONTROLER	1
73	RPOR0259	CABLE 4 OUTPUTS + LEDS	4
100	RPOR0314	AQUATIC GRILL BLACK SPEAKER 2"	4
101	RPOR0320	MINISPEAKER BLACK 2"	4
102	RPOR0326	INFINITY BLUETOOTH SYSTEM	1

VALID FROM 09/06/2016

According to our policy of continuous improvement, dimensions, features or components of this product can be partially or completely changed without prior notice. It's Customer responsibility to verify that this is the last version of the drawing

02	09/06/2016	I.Pozo	Change blower pump and add audio
01	17/03/2016	I.Pozo	New spare template
00	13/01/2016	I.Pozo	Creation
Change No.	Date	Name	Modification
Remarks			
Dimensions in mm. General Tolerances +/- 10mm			
Drawn	13/01/2016	I.Pozo	
Checked		V.Saiz	
Scale 1:15	General Tolerance DIN 7168 ISO 2768g		
Sheet 2/3			
		SPARE PARTS DRAWING	
		Part Number	Rev.
		66031	02
		First Angle Projection 	
Property of IBERSPA S.L. Avda. Pla d'Urgell 2-8 25200 Cervera, Spain. Don't use without permission. Keep this information confidential and use it solely for the permitted purpose.			

PUMPS SPARE CODES

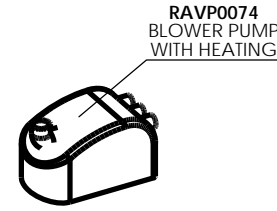
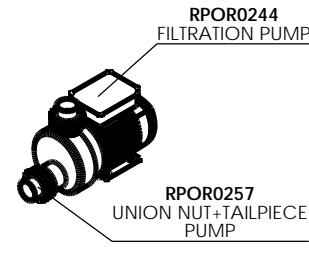
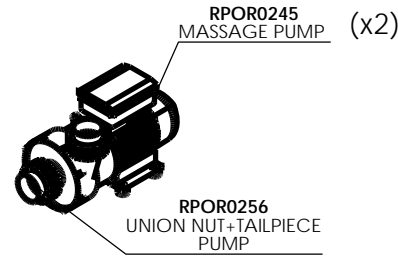

HEATER AND DESINFECTION SPARE CODES

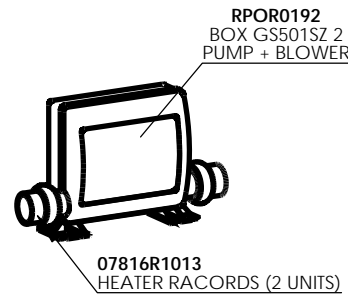

RPOR0101 - TEMPERATURE PROBES GS I GL (x 2)
RPOR0105 - HEATER 3 KW GS I GL
RPOR0197 - DIGITAL PANEL GS501SZ
RPOR0193 - EXPANDER BOARD KIT FOR SISTEM GS501SZ

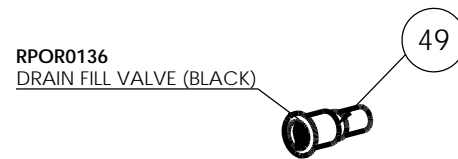

LIGHT COMPONENTS SPARE CODES

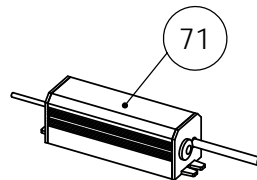
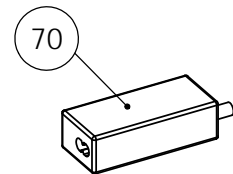

PURE LINE LIGHTING SPARE CODES

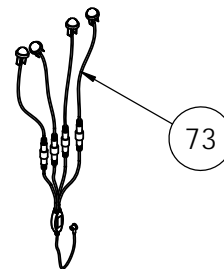

AUDIO SPARE CODES

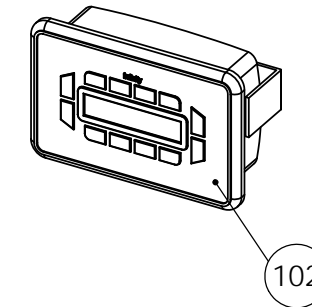
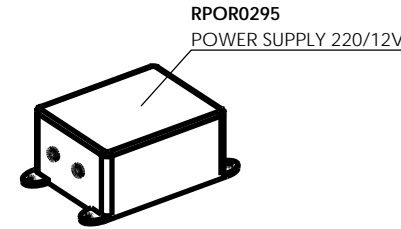
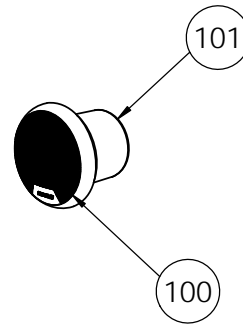
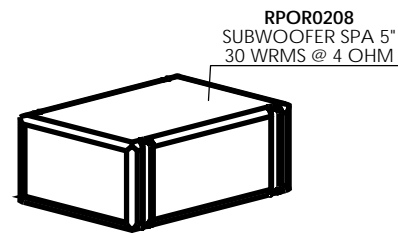

ACCESSORIES			
Position Num.	Part# SPARE	Description SPARE	Quant.
2	RPOR0275	SS SPA DRAIN 2" ADAPTOR SOCKET D.50	4
4	REMP0046	WHITE-STAINLESS STEEL AIR NOZZLE	12
8	RPOR0003	GREY DRAIN SET - BODY+COVER+ASSEMBLY	1
10	RPOR0239	SPOTLIGHT LED SET RD	5
10.2	RPOR0252	LED SLAVE LIGHT	5
11	RPOR0236	JET BODY SET RD 3"	22
12	RPOR0231	FRONTAL JET 3" STAINLESS STEEL DIRECTIONAL	8
13	RPOR0232	FRONTAL JET 3" STAINLESS STEEL 1 JET ROTO	12
14	RPOR0233	FRONTAL JET 3" STAINLESS STEEL TWIN ROTO	2
15	RPOR0235	JET BODY SET RD 2"	34
16	RPOR0230	FRONTAL JET 2" STAINLESS STEEL DIRECTIONAL	20
17	RPOR0260	JET TWIN ROTO 2" INOX	14
18	RPOR0261	VENTURY CONTROLLER SS	3
19	RPOR0263	VALVE ON-OFF 1" SS	2
20	RPOR0262	3 WAYS SS VALVE 2"	1
21	RPOR0264	AROMA DISPENSER ASM LIT	1
22	RPOR0238	SKIMFILTER RD LOW PROFILE	1
25	RPOR0196	DIGITAL PANEL VL700+COVER 2 PUMP + BLOWER	1
25.1	RPOR0202	COVER DIGITAL PANEL VL700 2 PUMP + BLOWER	1
28	RPOR0032	SMALL HEADREST GREY	3
30	RPOR0156	SKIMFILTER COVER	1
38	RPOR0247	FILTER CARTRIDGE SKIMFILTER RD	1
44	RPOR0278	SS 7" WATERFALL	2
49	RPOR0136	DRAIN FILL VALVE (BLACK)	1
50	RPOR0267	4 LEDS LIGHTS POINTS	7
51	RPOR0268	1 LED LIGHT POINT	4
55	RPOR0198	SPECIAL HANDGRIP SPA 1000	1
70	RPOR0280	LEDS TRANSFORMER 5V DC	1
71	RPOR0281	LEDS CONTROLER	1
73	RPOR0259	CABLE 4 OUTPUTS + LEDS	4
100	RPOR0314	AQUATIC GRILL BLACK SPEAKER 2"	4
101	RPOR0320	MINISPEAKER BLACK 2"	4
102	RPOR0326	INFINITY BLUETOOTH SYSTEM	1

VALID FROM 09/06/2016

According to our policy of continuous improvement, dimensions, features or components of this product can be partially or completely changed without prior notice. It's Customer responsibility to verify that this is the last version of the drawing

02	09/06/2016	I.Pozo	Change blower pump and add audio
01	17/03/2016	I.Pozo	New spare template
00	13/01/2016	I.Pozo	Creation
Change No.	Date	Name	Modification
Remarks			SPARE PARTS DRAWING
Dimensions in mm. General Tolerances +/- 10mm			
Drawn	13/01/2016	I.Pozo	
Checked		V.Saiz	
Scale	1:15	General Tolerance	Part Number 66031
Sheet	3/3	DIN 7168 ISO 2768g	
			Rev. 02
			First Angle Projection
Property of IBERSPA S.L. Avda. Pla d'Urgell 2-8 25200 Cervera, Spain. Don't use without permission. Keep this information confidential and use it solely for the permitted purpose.			